

# TROUBLESHOOTING

Check the following FAQ section before contacting us for repairs or other questions.

Symptom	Check here	Reference page
<b>Cleaner trouble during operation :</b>	<ul style="list-style-type: none"> <li>Is the power plug disconnected from the socket?</li> <li>If the cleaner body is overheated, the Filter care lamp (red) will flicker quickly, and the cleaner will not start. Leave the cleaner in a cool place for a while. Operation will be possible once the cleaner cools down. If the mesh filter or pleat filter is clogged, wash with water.</li> </ul>	---
<b>Cleaner doesn't start</b>	<ul style="list-style-type: none"> <li>The dust cup assembly filter is dirty. Remove the dust cup assembly, turn the filter knob, and empty the contents.</li> </ul>	7-9
<b>The Filter care lamp (red) is ON</b> <small>Page 4</small>	<ul style="list-style-type: none"> <li>If the suction opening is blocked, this lamp may turn ON even if the filter is not dirty. In this case, press "OFF" and resume operation. The lamp will turn OFF.</li> </ul>	5,6
<b>Suction force is weak or has changed</b>	<ul style="list-style-type: none"> <li>The motor is automatically controlled so that the hot air reaches a temperature range suitable for cleaning mattress. The motor power will change automatically during operation, but this is not a problem.</li> <li>If the suction opening is removed from the bedding for more than one minute, the power will automatically turn OFF. (Auto OFF)</li> </ul>	---
<b>Running sounds have changed or increased</b>	<ul style="list-style-type: none"> <li>For safety purposes, operation will automatically stop approx. 30 minutes after starting.</li> <li>Is the mesh filter or pleat filter clogged? Remove the filters and wash with water.</li> </ul>	---
<b>Operation stops</b>	<ul style="list-style-type: none"> <li>Is the dust cup full of dirt?</li> <li>Is any large item such as tissues, etc. stuck inside the dust cup?</li> <li>Is the suction opening blocked with dirt? Remove the blocked dirt.</li> </ul>	7-9
<b>The Filter care lamp (red) is flickering quickly</b> <small>Page 4</small>	<ul style="list-style-type: none"> <li>When using in a hot environment, such as during summer, the Filter care (red) may flicker quickly even if the filter is not clogged. In this case, leave the cleaner in a cool place for a while. Operation will be possible once the cleaner cools down.</li> </ul>	6,7 6,7 ---
<p>If the cleaner stops during operation even after taking the above actions, contact your dealer or the Customer Support Center.</p>		
<b>Hot :</b>		
<p>The cleaner body, power plug and power cord may reach a temperature of 40 to 60°C during operation, but this is not a problem.</p>		
<b>Cleaner body is hot</b>	<ul style="list-style-type: none"> <li>Is the mesh filter or pleat filter clogged?</li> </ul>	7-9
<b>Beating rubber blade :</b>	<ul style="list-style-type: none"> <li>The optical sensor will detect when the suction opening is lifted off the bedding during cleaning, and the beating rubber blade will stop for safety purposes.</li> <li>The optical sensor may not react when using the cleaner on dark-colored (e.g., black or navy) bedding, so the beating rubber blade may stop. However, cleaning can be continued in this state.</li> <li>Are hairs or thread scraps wound around the rubber blade?</li> <li>When cleaning bedding that sits closely against the suction opening, the fabric could be sucked up. The function to automatically stop the beating rubber blade will activate and cause the rotation to stop. Turn the power OFF once in this case. The function will be deactivated and operation can be resumed.</li> </ul>	---
<b>Beating rubber blade doesn't rotate</b>		10,11 ---
<b>Odors :</b>		
<b>The exhausted air smells</b>	<ul style="list-style-type: none"> <li>Is the dust cup full of dirt? (The dirt may smell depending on the type.)</li> <li>Was the mesh filter or pleat filter sufficiently dried after washing with water? (Using the cleaner with wet filters can cause smells.)</li> </ul>	6,7 7-9

**SHARP**  
SHARP CORPORATION  
Osaka, Japan

Printed in China  
TINSEA160VBRZ 15J- (CN) ①

# SHARP®

## MATTRESS VACUUM CLEANER OPERATION MANUAL

MODEL

# EC-HX100M-S EC-HX100P-S

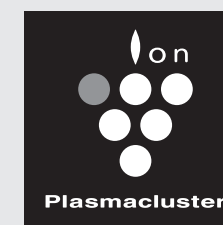

Plasmacluster is a registered trademark of Sharp Corporation in Japan, Philippines and elsewhere. Device of a cluster of grapes is a trademark of Sharp Corporation.

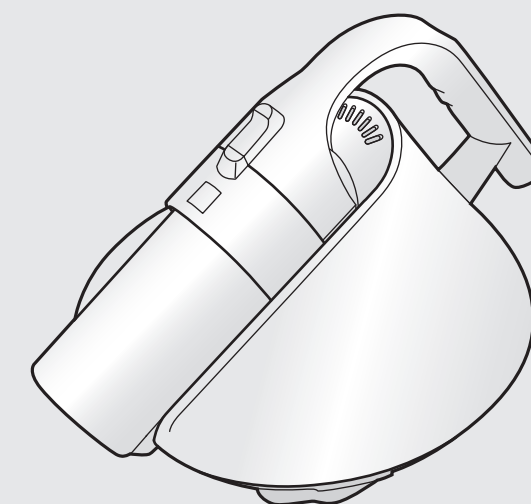

Thank you very much for buying SHARP. Before using your SHARP vacuum cleaner, please read this operation manual carefully to obtain the best use from your vacuum cleaner.

## SAVE THESE INSTRUCTIONS

### ⚠ WARNING

To reduce the risk of fire, electric shock or injury:

- 1 Electric shock could occur if used outdoors or on wet surfaces.
- 2 Do not leave unattended when plugged in, unplug from outlet when not in use and before user-serving.
- 3 Close attention is necessary when used by or near children. Do not allow to be used as a toy.
- 4 Use only for intended use as described cord or plug, if it is not working properly, if it has been dropped, damaged exposed to weather or dropped into water.
- 5 Never operate this vacuum cleaner if it has a damaged cord or plug, if it is not working properly, if it has been dropped, damaged, exposed to weather or dropped into water.
- 6 Do not pull or carry this vacuum cleaner by the power cord. Do not use the power cord as a handle, close a door on the cord, or pull the cord around sharp edges or corners. Keep cord away from heated surfaces. Do not run this vacuum cleaner over the cord.
- 7 Never disconnect the plug by pulling on the cord. To disconnect from an outlet, grasp the plug, not the cord.
- 8 Never operate this vacuum cleaner with any air opening blocked. Keep the air opening free of dust, lint, hair and any other similar material. When the filter becomes dirty, rinse in water. Filter should be completely dry before reusing.
- 9 Never drop or insert any object into any opening.
- 10 Never operate this vacuum cleaner without a dust cup.
- 11 Before removing the plug from the outlet, push switch to "OFF".
- 12 Never handle the plug, cord or vacuum cleaner with wet hands.
- 13 Do not place heavy objects on the vacuum cleaner.
- 14 Do not expose this vacuum cleaner to high temperatures while operating or during storage.
- 15 Store this vacuum cleaner in a dry place.
- 16 Use the carrying handle of the body to carry this vacuum cleaner.
- 17 Children should be supervised to ensure that they do not play with the appliance.
- 18 Operate vacuum cleaner only at the voltage specified on rating label.

### Stop use immediately if following abnormality or trouble occurs:

- The cleaner sometimes does not start even when switch is turned ON.
- Power stops when the power plug or power cord is moved.
- Operation sometimes stops.
- Abnormal noise is heard during operation.
- The cleaner body is deformed or abnormally hot.
- It smells like something is burning.

Press "OFF" immediately and disconnect the power plug from the outlet. Refer to "TROUBLESHOOTING", and contact your dealer for repairs.

# IMPORTANT SAFETY INSTRUCTIONS

- **Do not use a loose outlet.**
- **Use an independent outlet.** (Sharing an outlet with other devices can cause heating and fires)
- **Periodically dust off the power plug.** Disconnect the plug and wipe it with a dry cloth. (Dust, etc. accumulated on the plug could adsorb moisture and cause an insulation fault, or could cause a fire.)
- **Insert the power plug completely into the outlet.** (An incompletely inserted plug could cause fires, electric shocks or short circuits.)
- **Always disconnect the power plug before starting servicing or inspections.** (There is a risk of electric shocks or injury.)
- **Do not use the cleaner near flammable matters, or allow the cleaner to suck such matters in.** Kerosene, gasoline, incense / Benzene, paint thinner / Cigarette butts / Flammable matter such as toner, etc. **There is a risk of explosions and fires.**
- **Do not wash the cleaner with water.** (Excluding parts that can be washed with water.)
- **Never disassemble or repair the cleaner.** (There is a risk of fires, electric shocks or injury.)
- **Do not touch the beating rubber blade, the optical sensor or the area around the exhaust vent during operation or immediately after operation.** (There is a risk of injury or burns to hands, etc.)
- **Pay special attention to children.**
- **Do not attach stickers or tape onto the optical sensor.** (There is a risk of malfunctions or faults.)
- **Service the optical sensor to prevent malfunctions.** (Page 11)  
(There is a risk of injury or faults if the optical sensor malfunctions.)
- **Do not leave the cleaner operating for a long time at the same place.** (Fabric could be damaged.)
- **Do not insert metals or pins into the cleaner body.** (There is a risk of electric shocks or faults.)
- **Do not use the cleaner for applications other than fabric products such as bedding (coverlet, mattresses, bed covers, mattress pads, blankets or pillows), cushions or sofas.**
- **Do not use the cleaner for applications such as embroidered or embossed fabrics, mite-resistant fabrics, leather products, vinyl products, flooring or clothing, etc.** (There is a risk of damage to the cleaner, fabric or floor, etc.)
- **Do not use the cleaner on wet bedding.** (There is a risk of bedding becoming smelly or the cleaner fault.)
- **Do not use the cleaner on bedding that is hanging.** (The cleaner could drop and cause injuries or faults.)
- **Check the bedding's heat resistant temperature before using.** (There is a risk of fabric damage or fires.)  
**The maximum hot air temperature is 65°C.**  
The outer surface of the bedding could be damaged if the wheels on the bottom of the cleaner are worn. The wheels must be replaced if they are worn. Stop use of the cleaner, and contact your dealer. (\* The cleaner must be sent in for repairs.)
- **Do not suck up the following types of substances.** (The inside of the cleaner could be damaged, dirt could build up, and faults could occur.)  
Liquids or wet dirt / Hot objects (cigarettes, hot ashes, matches, etc.) / Strings / Sharp objects (glass, razors, etc.) / Large amounts of sand / Sucking up large pieces or amounts of dirt at once
- **Clean each filter if fine powders have been sucked up.** (Page 7-9)  
(Plaster, cement, chalk, etc.)
- **Do not operate the cleaner without the dust cup assembly mounted.**
- **Do not pull the storage stand.** (It could damage the floor, etc.)
- **Do not oil the beating rubber blade.** (The plastic could break.)
- **Noise may appear on a television screen during use, but the television itself will not be affected.**
- **Do not use cosmetics, etc. that contain fluororesin or silicone\* near the mattress cleaner.** (The insulation matters such as fluororesin or silicones, etc. could adhere in the cleaner unit and prevent the generation of plasmacluster ions.)  
\* Hair care products (split end coating, hair mousse, hair treatment, etc.) cosmetics, antiperspirant, anti-static agents, waterproofing spray, polishing agent, glass cleaner, chemical rags, wax, etc.
- **This appliance is not intended for use by persons (include children) with reduced physical, sensory or mental capabilities, or lack of experience and knowledge, unless they have been given supervision or instruction concerning use of the appliance by a person responsible for their safety.**

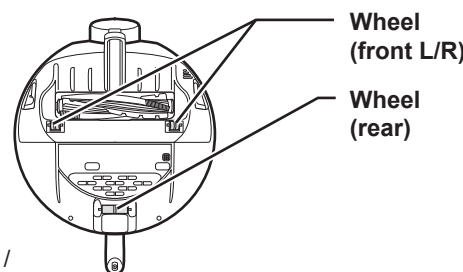
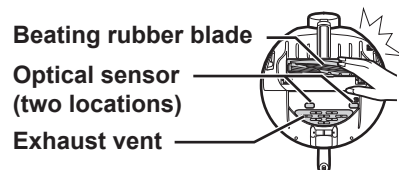

**Caution:**  
If the cord of this appliances is damaged, it must only be replaced by the repair shop appointed by SHARP. In order to avoid hazard.

**WARNING**  
Always disconnect the power plug before starting servicing or inspections. (There is a risk of electric shocks or injury.)

## Mounting the Beating Rubber Blade

Attach the belt onto the gear on the beating rubber blade bracket (left).  
Set the rubber blade into the slot, and insert the other side into the right bracket (with no gear).

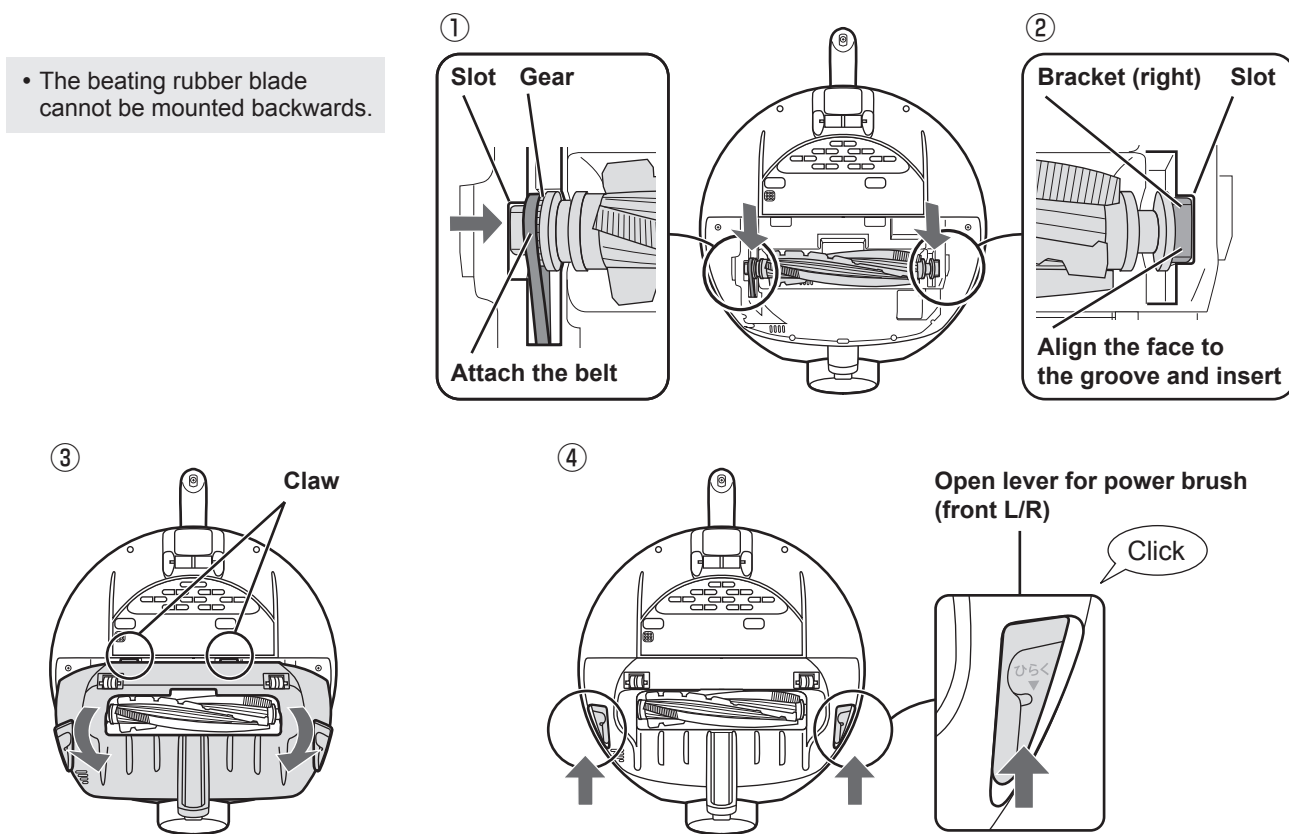

## Cleaner Body and Storage Stand

**When cleaner body (surface, dust cup assembly storage section, base) or storage stand is dirty**

Wipe clean with a cloth wetted with water or a diluted neutral detergent and squeezed out well.

- Do not use detergents, thinners, benzene or hot water (approx. 40°C or hotter).  
[ There is a risk of decomposition or deformation. ]

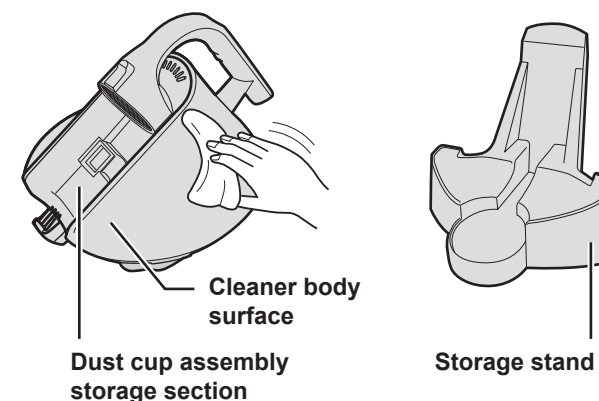

**When optical sensor is dirty**

Wipe the optical sensor clean with a dry cloth.

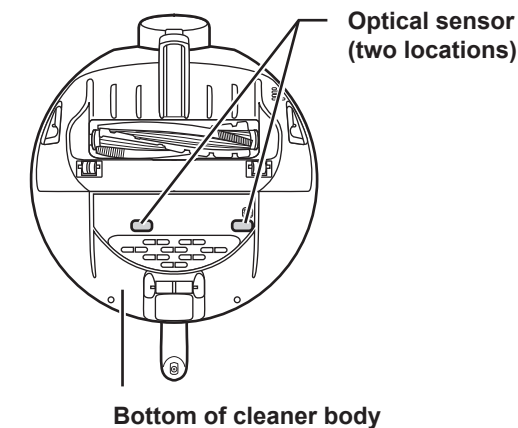

**Cautions** • The cleaner body and storage stand cannot be washed with water.



## Beating rubber blade

Replace the rubber blade with a new one if the rubber blade section is worn.

### Removing the Beating Rubber Blade

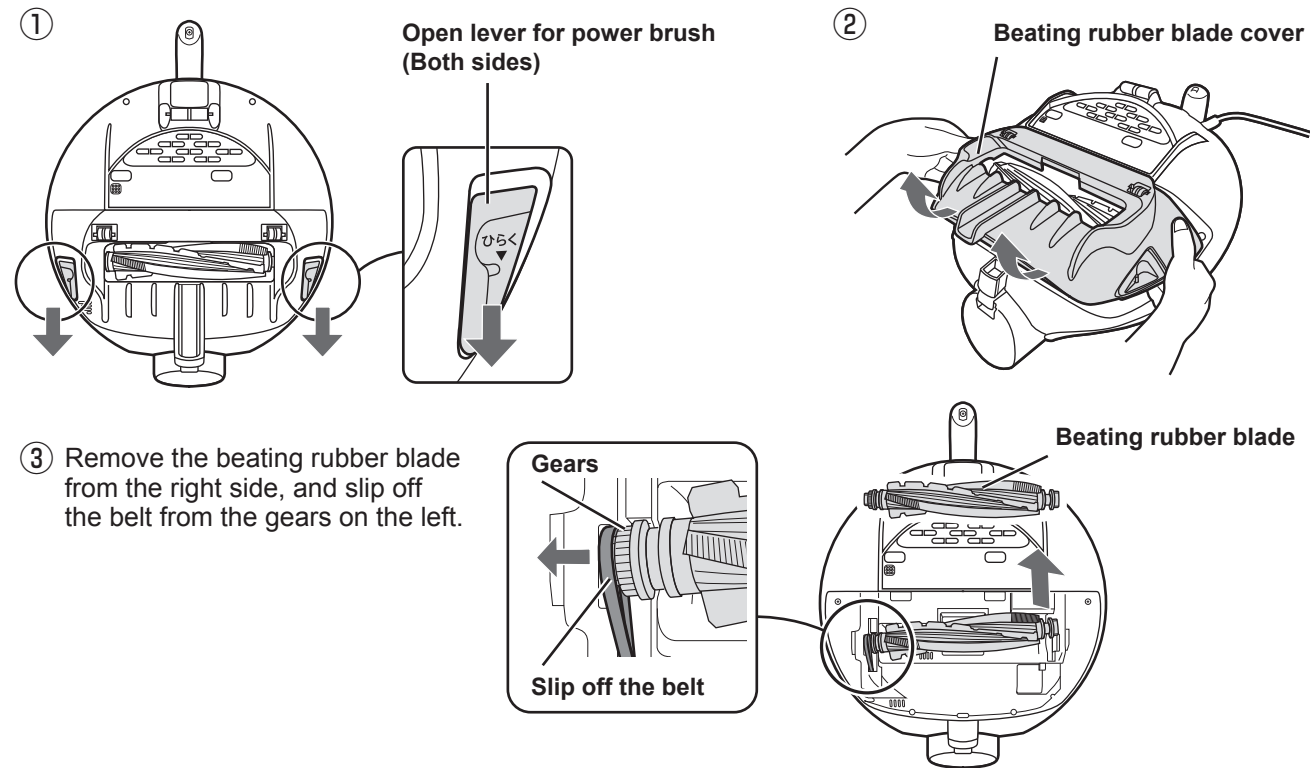

### Cleaning the Beating Rubber Blade

Use scissors to cut off any entangled thread scraps or hair, etc.

- Do not cut the tips of the rubber blade bristles.
- Pay attention to avoid injury.

#### Beating rubber blade

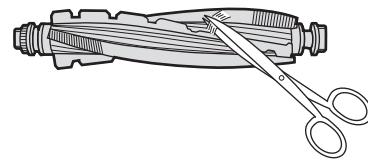

- : Water-washable
- × : Detergents not permitted [ There is a risk of malfunctioning. ]

Wipe clean with a cloth wetted with water and wrung well.

- Do not use thinners, benzene or hot water (approx. 40°C or hotter). [ There is a risk of decomposition or deformation. ]

#### Beating rubber blade cover

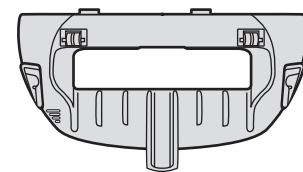

- : Water-washable
- : Diluted neutral detergent can be used

#### Cleaner body (with beating rubber blade removed)

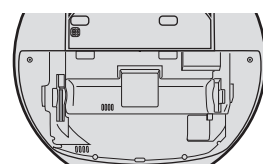

- × : Water-washing not permitted

**Cautions** • The cleaner body cannot be washed with water.

### After washing with water

- Shake off as much water as possible, and leave in a well-ventilated shady place to dry completely. [ Failure to dry the rubber blade properly will cause odors or faults. ]
- Do not dry the rubber blade with hot air, such as with a dryer. [ There is a risk of deformation or faults. ]

## NAMES OF EACH PART

### CLEANER BODY

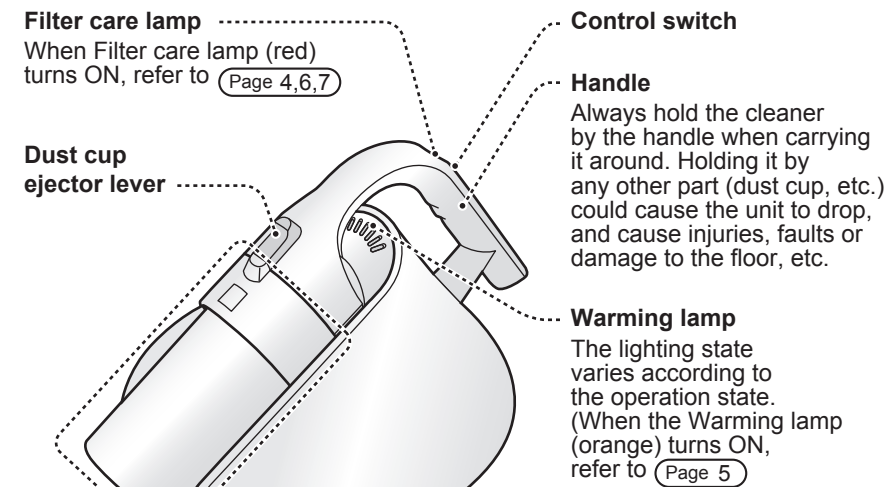

### ACCESSORIES

- Storage stand ( × 1 )
- Operation Manual ( × 1 )

### DUST CUP ASSEMBLY

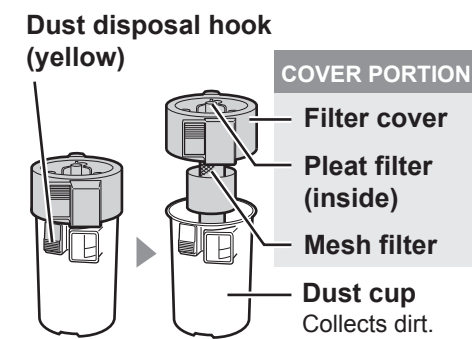

When the Dust disposal hook (yellow) is pressed, the dust cup will come off and the contents can be emptied. (Page 6,7)

Refer to Page 7-9 when servicing each filter.

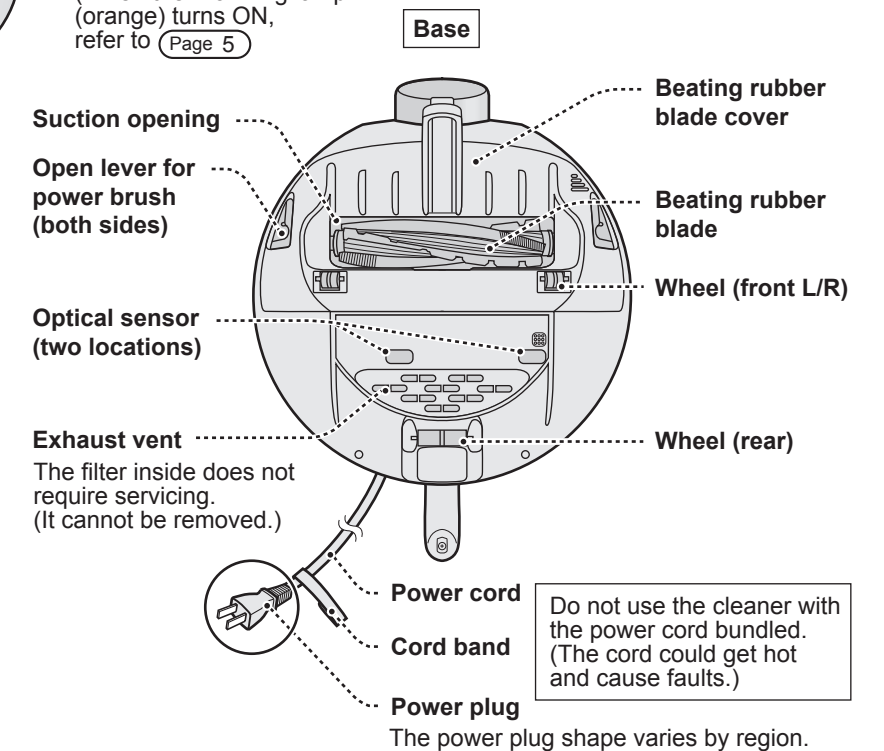

Do not use the cleaner with the power cord bundled. (The cord could get hot and cause faults.)

## SPECIFICATIONS

Power	220-240V 50-60Hz
Power consumption	720W
Dust collection capacity	0.1L
Weight	2.7kg(Including power plug)
Main unit dimensions	304mm(W) x 405mm(D) x 254mm(H)
Cord length	5m

### Information on the motor life

The mattress cleaner's motor has a life, and when it reaches its service life, the power will shut off. There may be abnormal smells and noises generated when the motor parts (carbon brush) wear.

Stop use of the cleaner and disconnect the power plug before contacting your dealer.

# USING THE CLEANER

## FLOW OF CLEANING PROCESS

**Control switch**

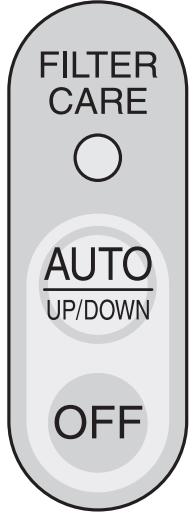

**Starting**  **Press only once. The hot air will be automatically controlled to the optimum temperature.**

To use the hot air effectively, wait for the Warming lamp on the cleaner body to light before starting. It will gradually change from a flicker to a steady light in approx. 30 seconds. (The cleaner can be used when the light is flickering slowly.)

**Ending**  **The Warming lamp will turn OFF.**

**Switching the motor power**

**Press "AUTO UP/DOWN" during operation** **The motor power will switch.**

- The motor power state is indicated with the Warming lamp on the cleaner body. (Page 5)
- If the motor temperature (air temperature) is at the maximum temperature, the power cannot be changed. In this case, the Warming lamp will flicker shortly three times.

**When Filter care lamp (red) turns ON**

The Filter care lamp indicates the filter cleaning cycle. Service the filter as indicated below.

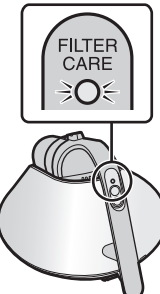
Filter care lamp (red)	Lighting state	State/Action
	<b>ON</b>	<b>Empty out the contents of the dust cup.</b> The dust cup assembly filter is dirty. Remove the dust cup assembly, turn the filter knob, and empty out the contents. (Page 6,7)
	<b>Fast flicker</b>	<b>Wash the filter with water.</b> The dust cup assembly filter is clogged with dirt. Remove the filter and wash it with water. (Page 7-9)

- Info**
- The optical sensor will detect if the suction opening is removed from the bedding during cleaning, and the beating rubber blade will stop. If the beating rubber blade does not stop, the optical sensor may be dirty.
  - If the suction opening is removed from the bedding for more than one minute, the Power lamp will automatically turn OFF and the Warming lamp will turn OFF. (Auto OFF)
  - The beating rubber blade's rotation speed will not change even if the power is switched.
- Notice**
- Do not touch the beating rubber blade, the optical sensor or the area around the exhaust vent during operation or immediately after operation. [ There is a risk of injury or burns to hands, etc. ]
  - Use of the cleaner in a room temperature of 10 to 35°C is recommended.

## Assembling the Filters

- Cautions**
- The parts cannot be mounted onto the cleaner if they are not assembled correctly.
  - Take care not to lose the mesh filter (bottom) when emptying the dust cup or cleaning the filters.
  - The filters cannot be assembled if there is any dirt in the base of the dust cup.
  - The filters cannot be assembled if dirt is wound around the mesh filter.

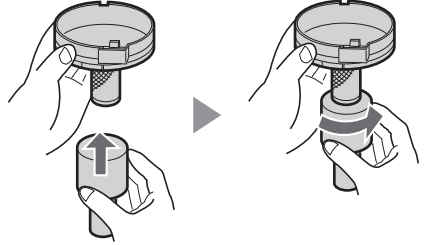
① 

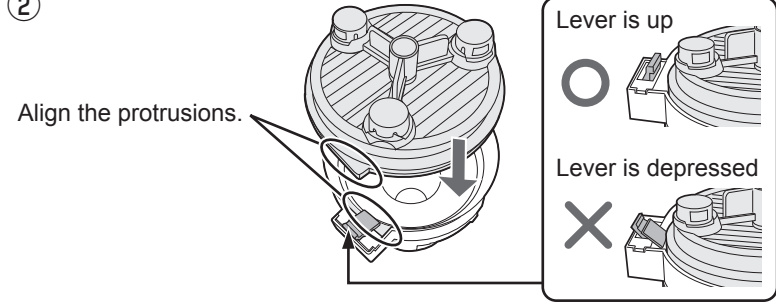
②  **Align the protrusions.**

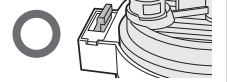
**Lever is up** 

**Lever is depressed** 

- Make sure there is no dirt or foreign matter in the mesh filter before mounting. [ There is a risk of abnormal noise. ]

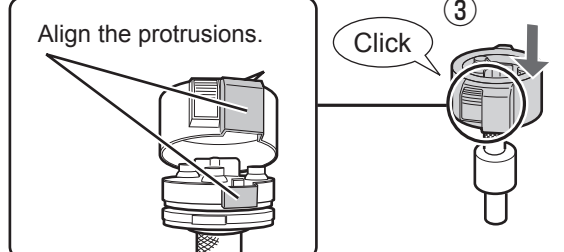
**Align the protrusions.**  **Click** ③

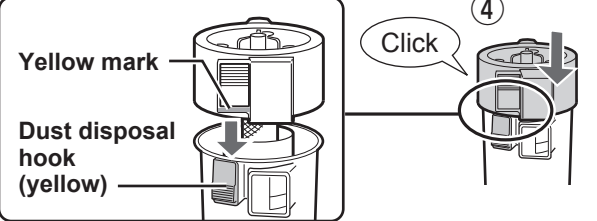
**Yellow mark**  **Click** ④

**Dust disposal hook (yellow)**

## Wheels

- If the wheels are worn, stop use and contact your dealer and Sharp Service Center.
- Use scissors to cut off any entangled thread scraps or hair, etc.
- Pay attention to avoid injury.

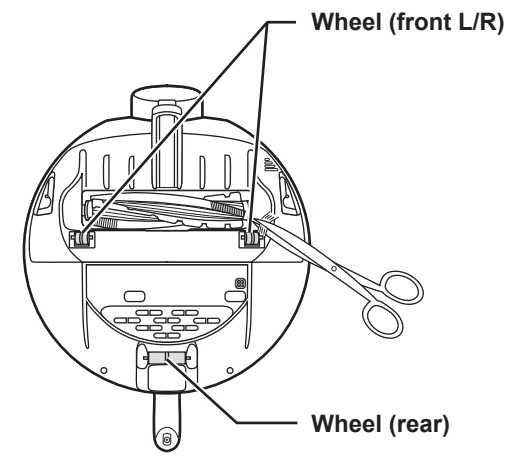

# MAINTENANCE (Continued)

## WARNING

Always disconnect the power plug before starting servicing or inspections. (There is a risk of electric shocks or injury.)

### Removing the Filters

- Turn the filter knob approx. ten times.

- Tap the dirt on the pleat filter into the dust cup.

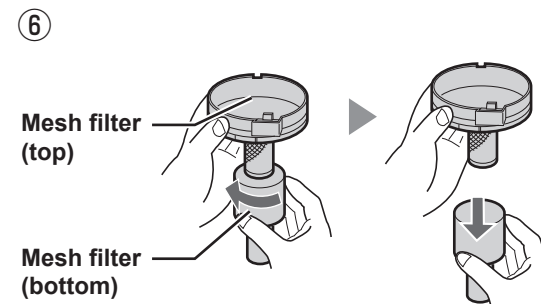
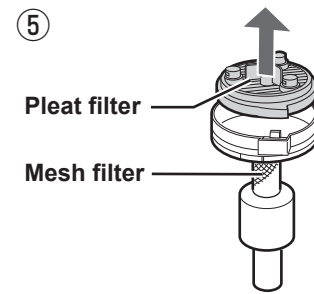
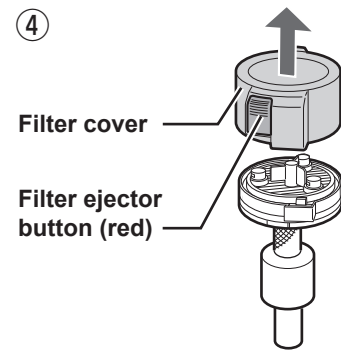
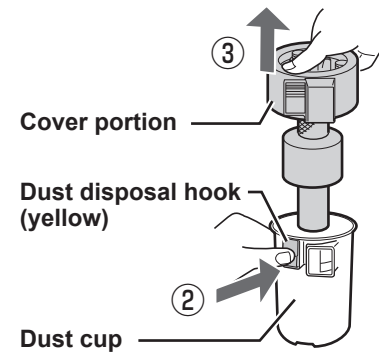
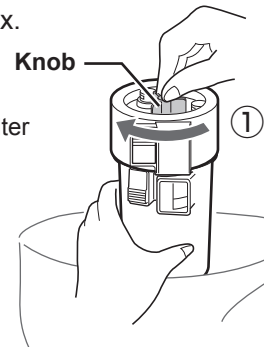

### Washing the Filters

#### Pleat filter

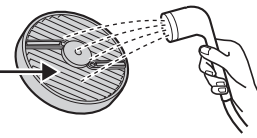

Wash the back side thoroughly.

- If there are heavy odors or contamination, soak the filter in a solution of 10ml clothing-safe bleach and 1 liter of water for approx. 3 hours. Then, wash well with water.



#### Mesh filters (top and bottom) / Filter cover and dust cup

Wash with water or a diluted neutral detergent.

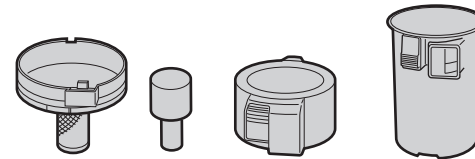

### After washing with water

- Shake off as much water as possible, and then gently wipe with towels to remove excess water. Leave the filters to dry in a well-ventilated shady place. [ Failure to dry the filters properly will cause odors or faults. ]

Guide to drying time: 12 hours (This varies by the environment and seasons.)

- Do not dry the filters with hot air, such as with a dryer. [ There is a risk of deformation or faults. ]

### Warming lamp (orange) lighting state

During cleaning, the Warming lamp will turn ON as shown below to indicate the operation state.

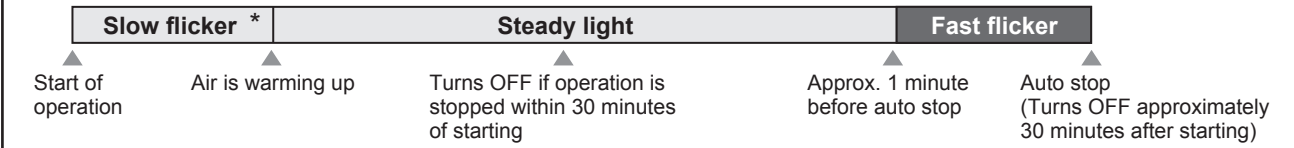

Lamp state	Operation state
Slow flicker	Warming air with maximum power. Dust can be vacuumed even if the air temperature is low.
Steady light	Air is starting to warm up. The cleaner's effect against mites increases with hot air. The time required to reach a hot air level may vary according to the room's temperature.
Fast flicker	The operation will automatically stop approx. one minute after the lamp starts to flicker quickly, and the Warming lamp will turn OFF. To continue operation even after automatic stop, press "AUTO UP/DOWN" again to resume operation. For safety purposes, operation will automatically stop approx. 30 minutes after starting. The Warming lamp will flicker quickly approx. one minute before automatic stop.
OFF	When operating with the maximum power for heating the air, if the power is lowered by pressing "AUTO UP/DOWN", the lamp will remain OFF until the air heats up. (The lamp will automatically change to a steady light when the hot air level is reached.)
Flicker 3 times	If the motor temperature (air temperature) is at the maximum level, the power will not change even if "AUTO UP/DOWN" is pressed. The lamp will flicker quickly three times.

\* If hot air is discharged as soon as operation starts, the lamp will change to a steady light. (Ex. When starting operation soon after the previous operation.)

### Hints for Cleaning Mattress

- Lightly move the cleaner slowly back and forth as shown in the illustration. (Do not press down on the cleaner.)
- Clean one section back and forth two times to attain a cleaner state.
- At the start of operation, if the cleaner is set on the mattress rather than lifted up, the hot air will circulate and warm up the air faster.
- If there is a space between the mattress and cleaner body, the hot air will cause fine dust to scatter and possibly stick onto the cleaner body.

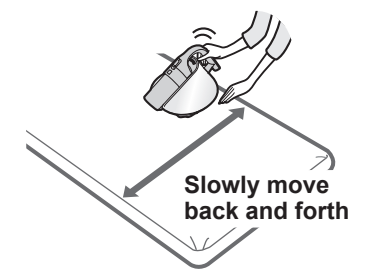

### Storing the Cleaner

Store the power plug outside of the storage section with the plug facing upward

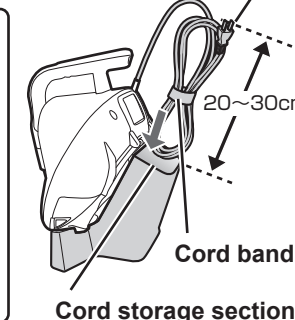
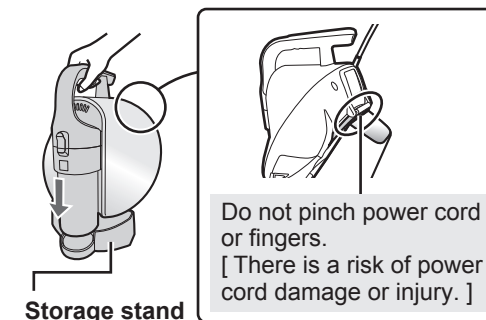

### Cautions

- Do not store the cleaner into the storage stand while it is running.
- Do not place the stand at an unstable place, such as a high pile carpet. [ The stand could fall over. ]
- Do not carry the cleaner around while it is stored in the storage stand. [ The cleaner could fall out of the storage stand and drop, causing injuries, damage the floor, or breaking. ]
- Do not pull the storage stand. [ It could damage the floor, etc. ]



# EMPTYING THE DUST CUP

## Guide for emptying the dust cup

- When the Filter care lamp (red) turns ON\*

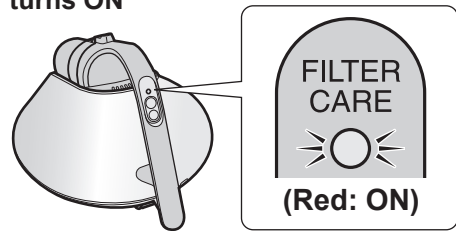

- When operation stops
- When suction force is weak
- When operation sound changes or becomes louder

Remove the dust cup assembly, turn the filter knob, and empty the contents. (See right.)

If the lamp is still ON, the filter must be cleaned. [Page 7-9](#)

- When dirt collects to "Dust Full" line

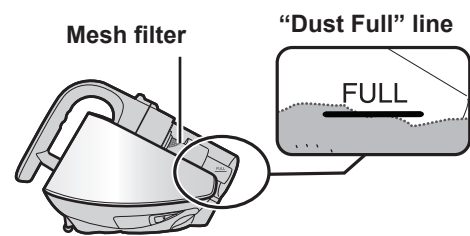

Even if the dirt is collected on one side, empty the dust cup before the dirt exceeds the line.

For sanitary purposes, the dust cup should be emptied after each cleaning session.

### Notice

- If operation is continued with a full dust cup, the dirt will adhere onto the mesh filter, and cause the suction force to drop.

## Removing the Dust Cup

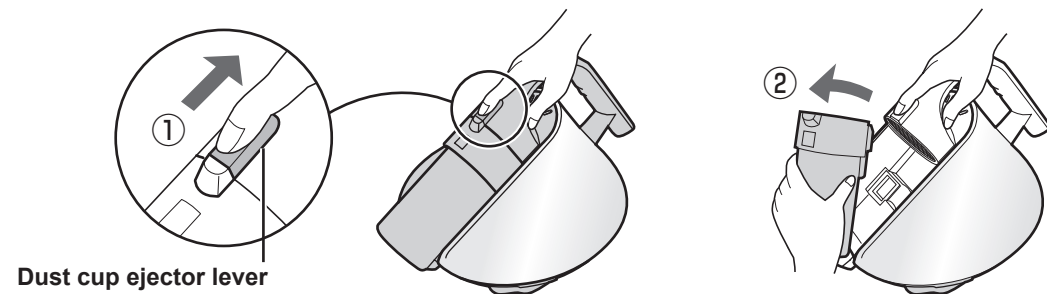

## Emptying the dust cup

- 1 Turn the filter knob approx. ten times.

- Tap the dirt on the pleat filter into the dust cup.

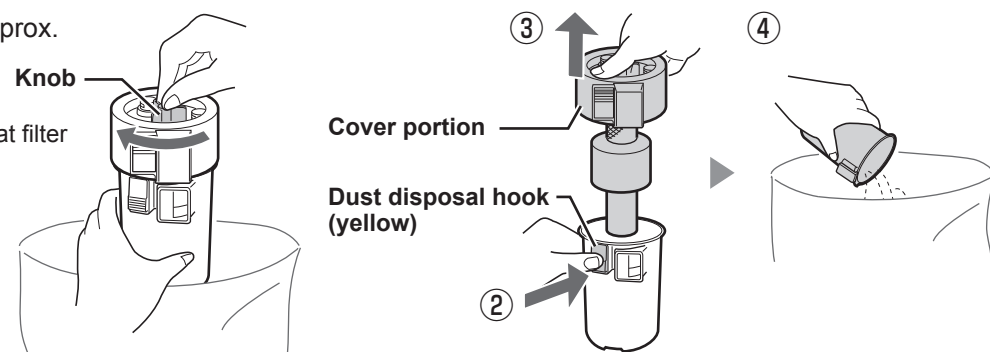

### WARNING

Always disconnect the power plug before starting servicing or inspections. (There is a risk of electric shocks or injury.)

## Mounting the Dust Cup

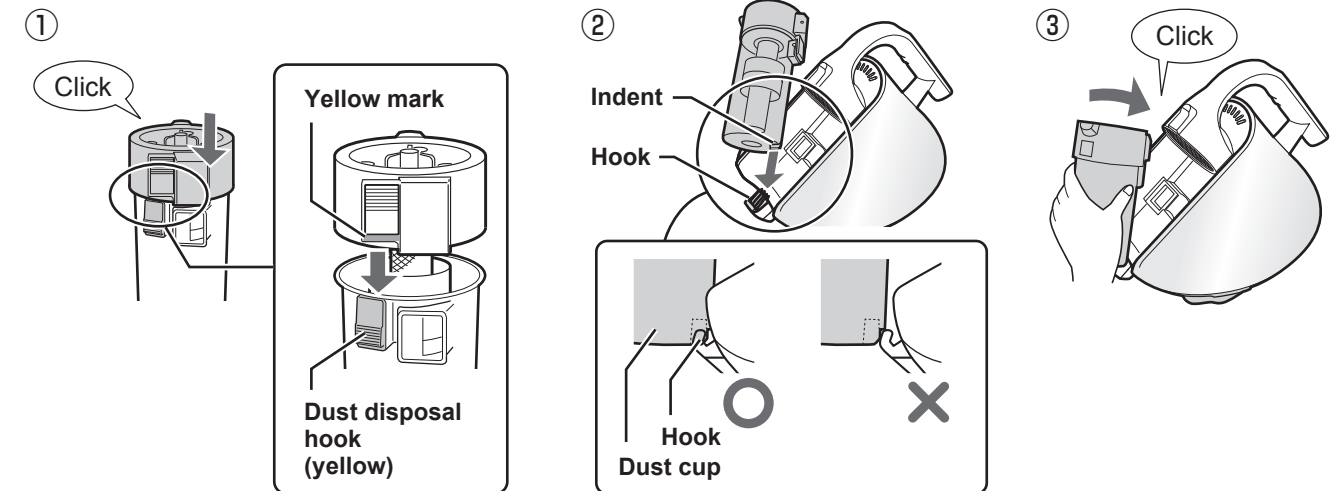

### Cautions

- Always follow the attaching procedure, and correctly set the dust cup assembly into the cleaner. Failure to do so could cause the suction force to drop, abnormal sounds to be heard, or dirt could enter the motor and cause faults.
- The dust cup assembly must be assembled to be properly mounted onto the cleaner.
- Do not lose the mesh filter (lower) when emptying the dust cup or cleaning the cleaner.
- The dust cup will not fit onto the cleaner body if there is dirt in the dust cup storage section.

# MAINTENANCE

- Wipe the cleaner with a soft cloth, etc. so the cleaner and floor are not scratched.
- Support the cleaner with a hand so that it stays stable.
- When removing and cleaning the dust cup assembly, clean the dust cup assembly storage section first.

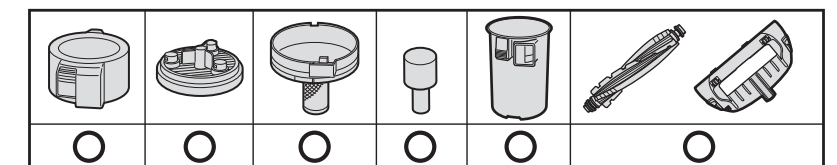

Parts that can be washed with water

## Dust cup assembly

## Guide for cleaning

Wash the dust cup and filter with water when the following states apply.

- When the Filter care lamp (red) flickers quickly\*

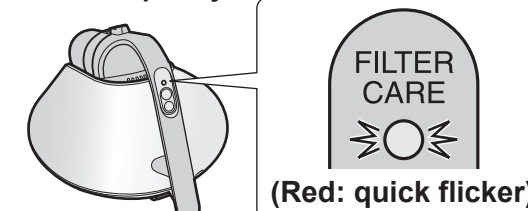

- When cleaner body is hot
- When fine powders have been sucked up
- When Filter care lamp (red) turns ON frequently

### Notice

- If operation is continued without cleaning, the cleaner will stop automatically. Even if cleaning is required, the Filter care lamp may not turn ON depending on the room temperature and operation state, etc. Clean the unit frequently.
- Do not use thinners, benzene or hot water (approx. 40°C or hotter).